

NOTE: ALL MATERIAL COMPLIANT ROHS STANDARD

REVISION INFORMATION			
Rev.	Rev.Date	Modified By	Brief Description
V2.0	Apr-11-2022	Mona	OPP Bag size changed to 60*80mm

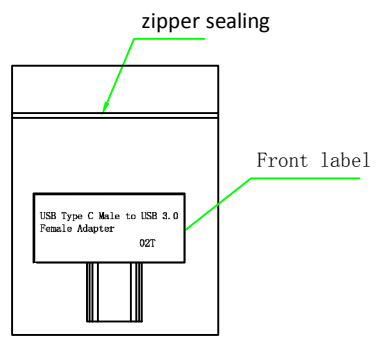

1. Bag size 60*80mm, label on the front of bag

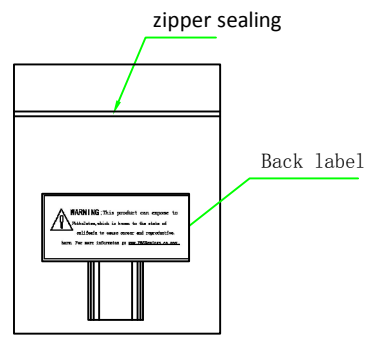

2. Bag size 60*80mm, label on the back of bag

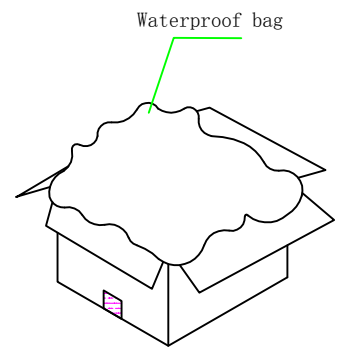

3. Master carton: 280*260*220MM, Put 1PCS waterproof bags in the carton before packing. 1000pcs per carton

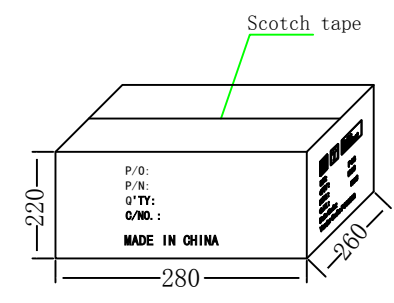

4. Stick main mark and side mark to the Master carton

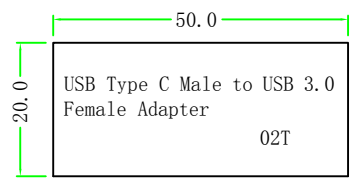

Front Label

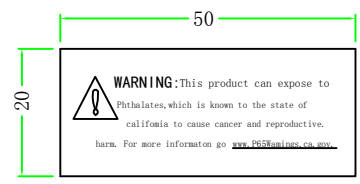

Back label

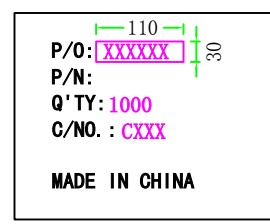

Main Mark

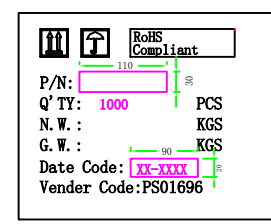

Side mark

DRAWN BY	DATE: 2022. 03. 17	DESCRIPTION: USB Type C Male to USB 3.0 Female Adapter
CHECKED BY	SHEET 1 of 1	ITEM NO. 150219
APPROVED BY	SCALE 1:1	REV. 00 UNIT: mm